

IMPACT BUFFERS

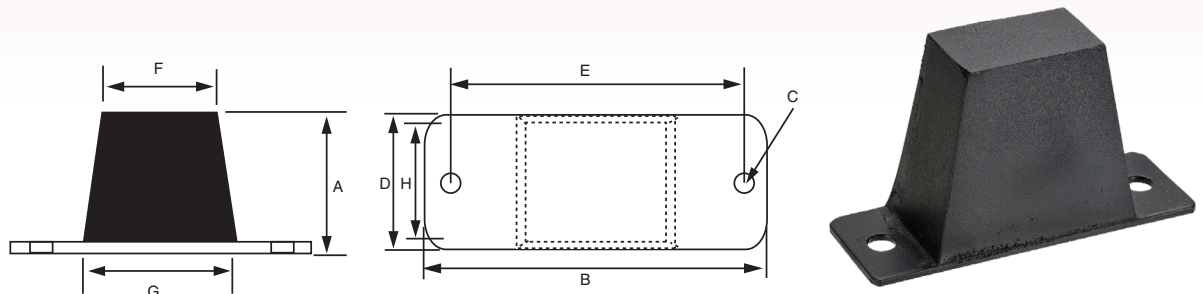

Part No.	A	B	C	D	E	F	G	H	STATIC LOAD Kg	DEF mm	BUFFING LOAD Kg	DEF mm	Weight Kg
M176	73	127	10	44	101	51	76	32	87	10	200	20	0.3

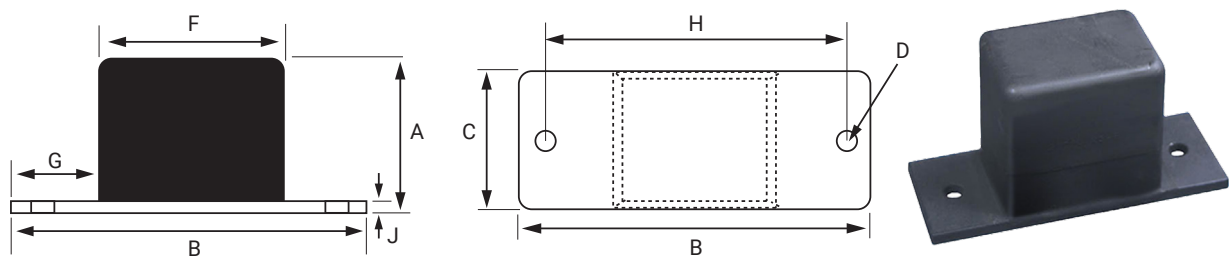

Part No.	A	B	C	D	F	G	H	J	STATIC LOAD Kg	DEF mm	BUFFING LOAD Kg	DEF mm	Weight Kg
MA5925055	70	130	50	8.5	70	30	100	5	87	10	200	20	0.5

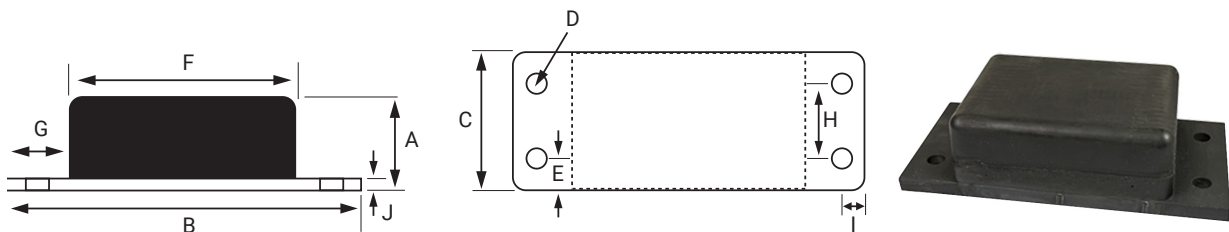

Part No.	A	B	C	D	E	F	G	H	I	J	STATIC LOAD Kg	DEF mm	BUFFING LOAD Kg	DEF mm	Weight Kg
MA5924455	80	200	100	13	25	120	40	50	20	10	700	10	3600	29	2.4
MA5921455	70	250	120	15	30	150	50	60	25	10	1300	9	6000	24	3.4
MA5921055	80	300	150	17	35	200	50	80	25	15	2250	10	10000	25	7.1

BONDED BUFFERS



M170



M175



M174
X2747

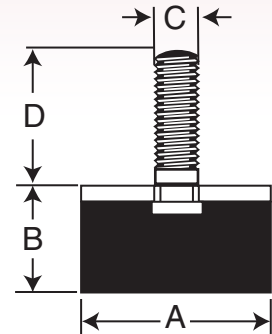

Standard Part No.	A (mm)	B (mm)	C	Duro	D (mm)	Static		Buffing		Weight Kg
						Load Kg	Def mm	Load Kg	Def mm	
M170	35	22	3/9 W	45	38	64	3	180	8	0.67
M175	63	36	1/2 W	45	33	115	5	400	12	0.21
M174	50	50	3/8 UNF	60	16	125	6	600	20	0.15
X2747	50	50	3/8 UNF	80	16	230	6	1250	20	0.15

Load must be placed on the metal surface and not on the stud.

FEATURES

This rectangular buffer is easily fitted. Reduction of transmitted shock loads enables equipment to be designed more economically.

This buffer is designed to protect structures and equipment from impact forces. It is usually fitted as non-metallic stops or incorporated in vehicle suspension systems to provide progressive stiffening under increasing load.

Typical applications:

- Dump trucks
- Off-road vehicles
- Cranes
- Handling equipment
- Vehicle suspensions

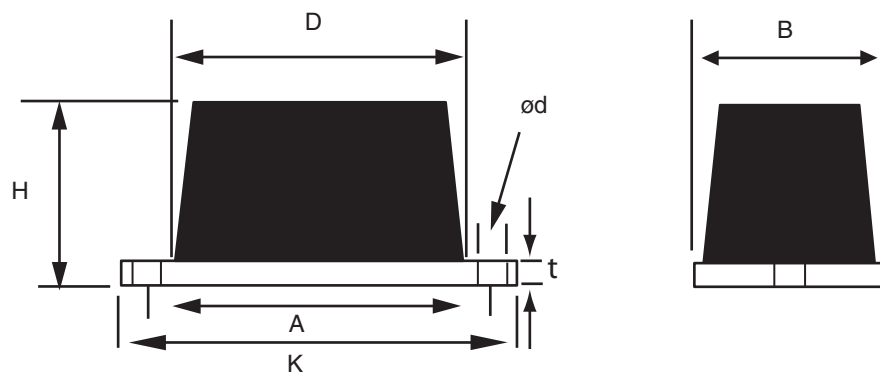

Part No	Dimensions							Compression		Weight Kg
	A	B	D	H	K	d	t	Load Kg	Def mm	
M15260	127	64	89	37	156	13.5	6.3	250	13	0.6

BONDED BUFFERS

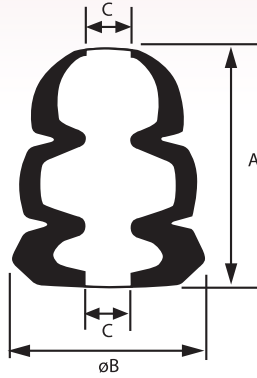

*Two Hole Mixing



PART No.	A	B	C	Static Load Kg	DEF mm	Buffing Load Kg	DEF mm	Weight Kg
M190	103	79	20	150	25	450	45	0.3

These buffers are equally adaptable when controlling impact or when used as machine feet; they also may be used as snub-bing rubbers when excessive shock loads are encountered in resiliently mounted equipment. A rugged rubber bonded to metal unit ensures simplicity of application and ease of installation.

MOULDED DOCKING BUFFER

Ideally suited to truck trays and loading bays

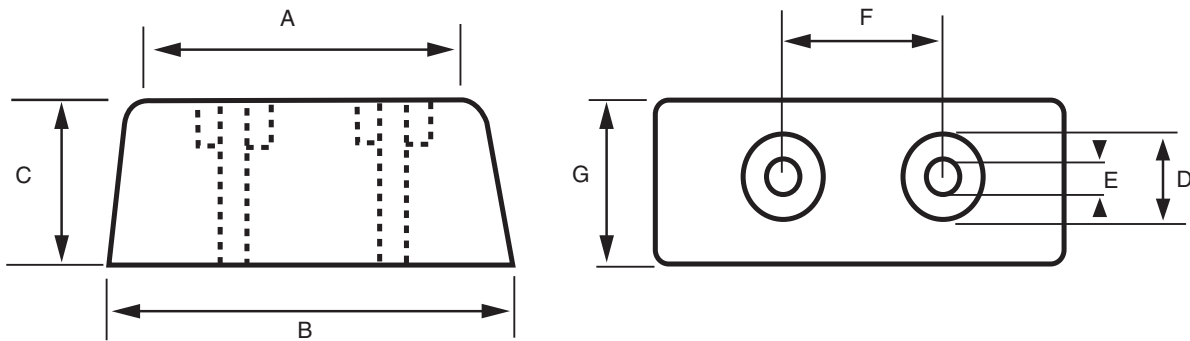

Part No.	A	B	C	D	E	F	G	Weight Kg
DB15090	145	150	90	40	13.5	75	76	1.2
DB15575	150	155	75	36	14	87	65	0.72
DB19555	185	195	50	32	11	120	55	0.62